



A MEMBER OF THE **ESTUN** GROUP

# TRIO MOTION TECHNOLOGY DX5 SERVO PACKAGES



THE MOTION SPECIALIST

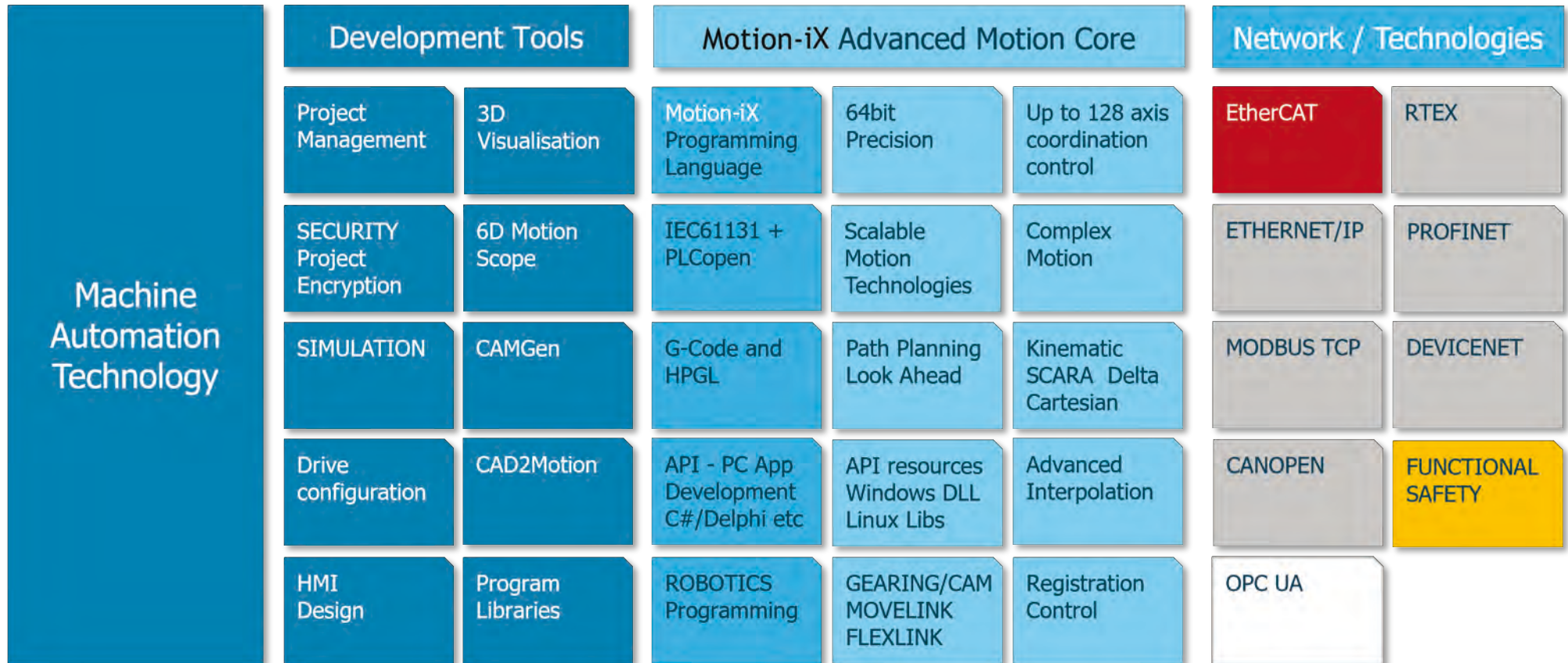

Combining an advanced motion core with Trio's ease-of-use, Motion-iX offers performance and dependability of packaged solutions, from "The Motion Specialist", where motion is the core and not just a bolt-on capability.

Motion-iX – a unified software engineering framework for machine development, that places the focus on optimising motion and complex kinematics, including robotics such as SCARA, to deliver truly optimal machine control performance.

Motion-iX includes development in IEC61131 and PLCopen, and boasts inverse kinematics

capabilities to truly coordinate all machine axes as one, including robots to maintain tight synchronisation or robots and machine as one. Virtualization allows simulation of the mechanics and motion to significantly reduce development and testing, delivering optimal control every time, by minimising machine cycle times.

# Motion Perfect

Design, Develop, Test, Deploy and Secure

Built on Trio's **Motion-iX** core technology, *Motion Perfect* provides the user with a re-designed easy to understand interface for rapid application development, controller and drive configuration and monitoring of functions.

The commissioning of DX Servo Drives is made simple with a series of Device Configuration Screens allowing access to status information and diagnostics at a glance. All motor axes can be detected, setup, monitored and controlled in real-time from the easy to use dialogue windows.

*Motion Perfect* includes access to IEC 61131 and PLCopen and the robotics solution; TrioRPS. Advanced visualisation including a 3D oscilloscope and IP protection of your projects are also included within *Motion Perfect*.

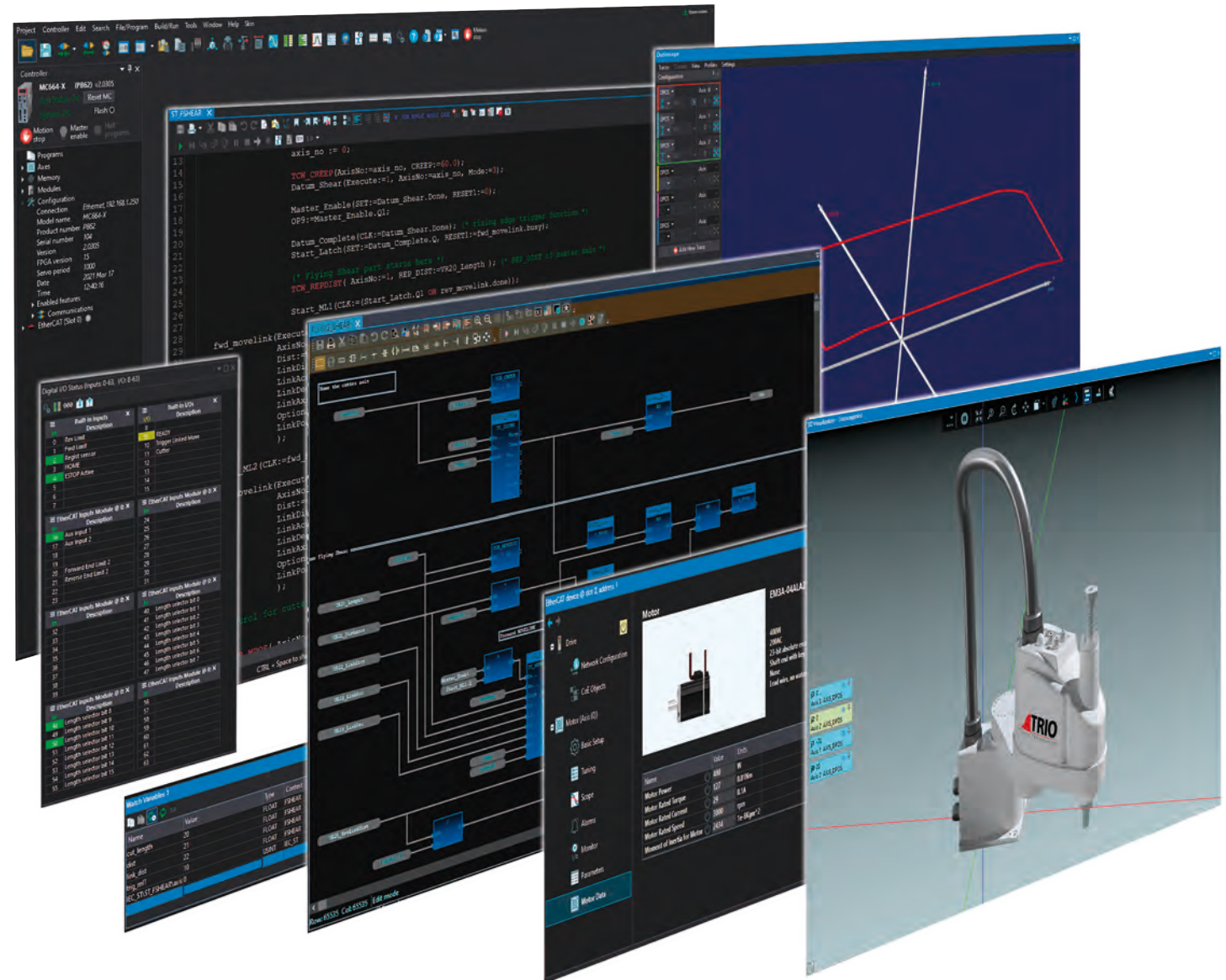

# DX5 Multi-Axis Servo Drives

EtherCAT®

**TRIO**  
MOTION TECHNOLOGY  
A MEMBER OF THE ESTUN GROUP

## AT A GLANCE

- ★ DX5 drives and Trio's motion controller fully integrated into *Motion Perfect*
- ★ EtherCAT network for motion control
- ★ Zero stacking gap installation
- ★ Optimized for multi-axis machines
- ★ 200V ac supply module
- ★ Dual 750W axis module, supporting 750W and 400W motors
- ★ Dual 400W axis module, supporting 400W, 200W and 100W motors
- ★ 23-bit multi-turn absolute encoder
- ★ 350% overload
- ★ Internal drive protection functions
- ★ Comprehensive tuning technology
- ★ Field upgradable firmware
- ★ Matched with MXL motors
- ★ I-O functions handled by motion controller as part of the DX series 'Everything you need nothing more' concept



Building on the Trio DX series concept of 'everything you need, nothing more', DX5 is highly optimised for high axis counts and designed to maximise efficiency in all stages of design, installation and operation. It's optimized hardware is designed to minimize cost in multi-axis motion systems by expanding at the controller and system I-O level.

Cabinet space is minimised by combining dual-axis drives units and DC power supply and reduced cabling and AC power side components.

This result can be an 8-axis system that uses 50% of a cabinet space of a typical AC servo system of similar power.

# DX5 Multi-Axis Servo Drives

## Efficiency-Benefits

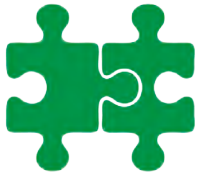

### Integration Efficiency

Rapid application development of controller and drive configuration within *Motion Perfect*.



### Space Efficient

Highly compact compared to standalone AC powered servo drives solution. AC power cabling and system wiring reduced by up to 80%.



### Design Efficient

One system to program, simplifying development and any future production changes when required.



### Energy Efficient

DC Bus regenerative energy is reused by the system. Energy savings for the life of the system, motor braking is absorbed and reused by all axes.

## DX5

### DX5-06KA

200V ac (3-phase)  
Power Supply Module

## DX5

### DX5-20404AEA

Dual 400W axis  
module, supporting  
**400W, 200W** and  
**100W** motors

## DX5

### DX5-20808AEA

Dual 750W axis  
module, supporting  
**750W** and **400W**  
motors

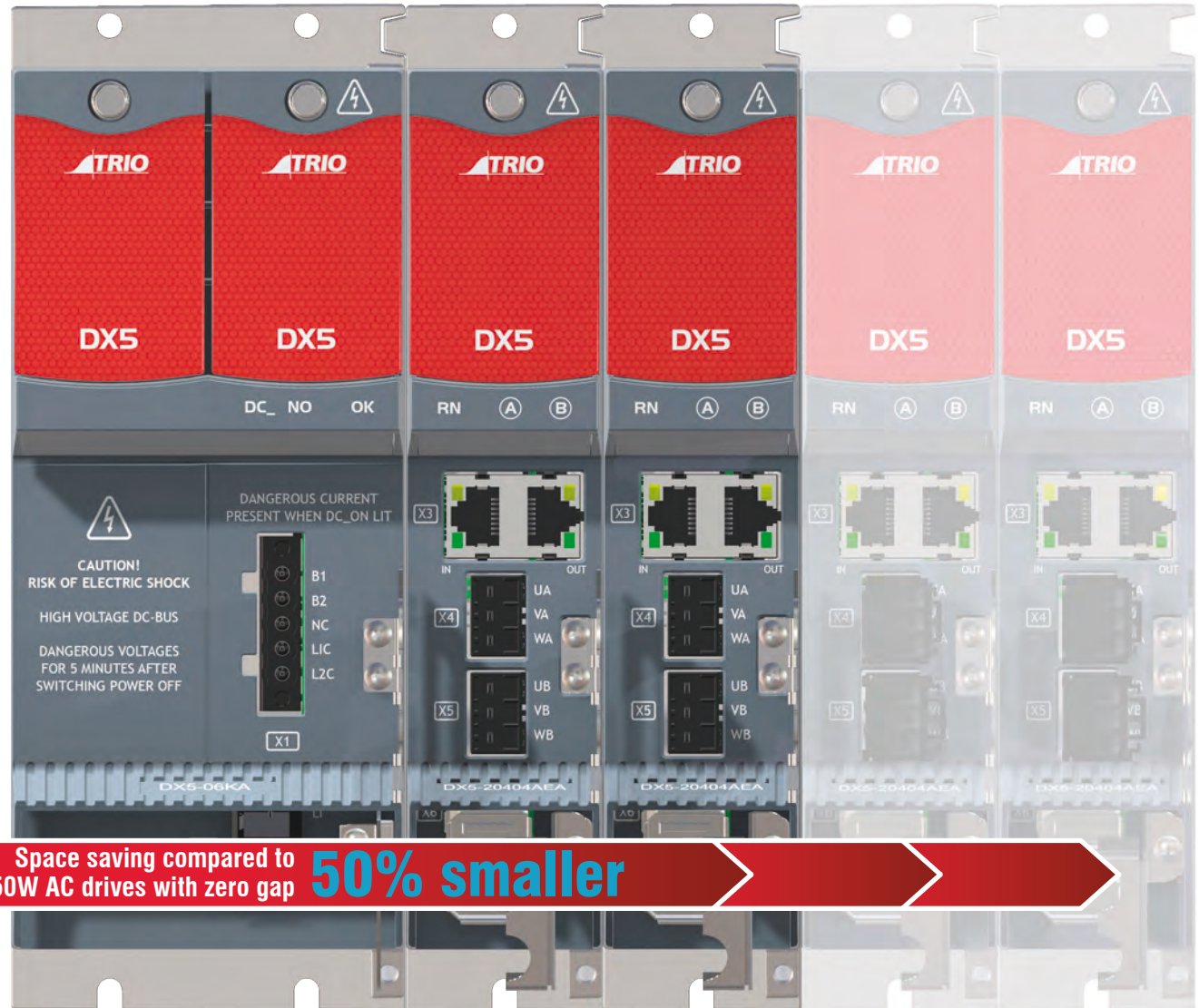

# APPLICATION SOLUTIONS

## Multi-Axis Servo Solutions

Scalable System Solutions for Machinery OEMs

### Factory Automation

Communicate on all major Ethernet Technologies and Fieldbus level networks.

### Automation Packages for Machine Control

Scalable Control Architectures.  
Open Communications and Tools.

### Motion Control Range

*Motion Coordinator* with scalable CPU performance.

Packaged Servo Offering.

Modular Decentralised IO Systems:

Digital / Analogue I-O, Stepper & Servo axes, Temperature Control and more.

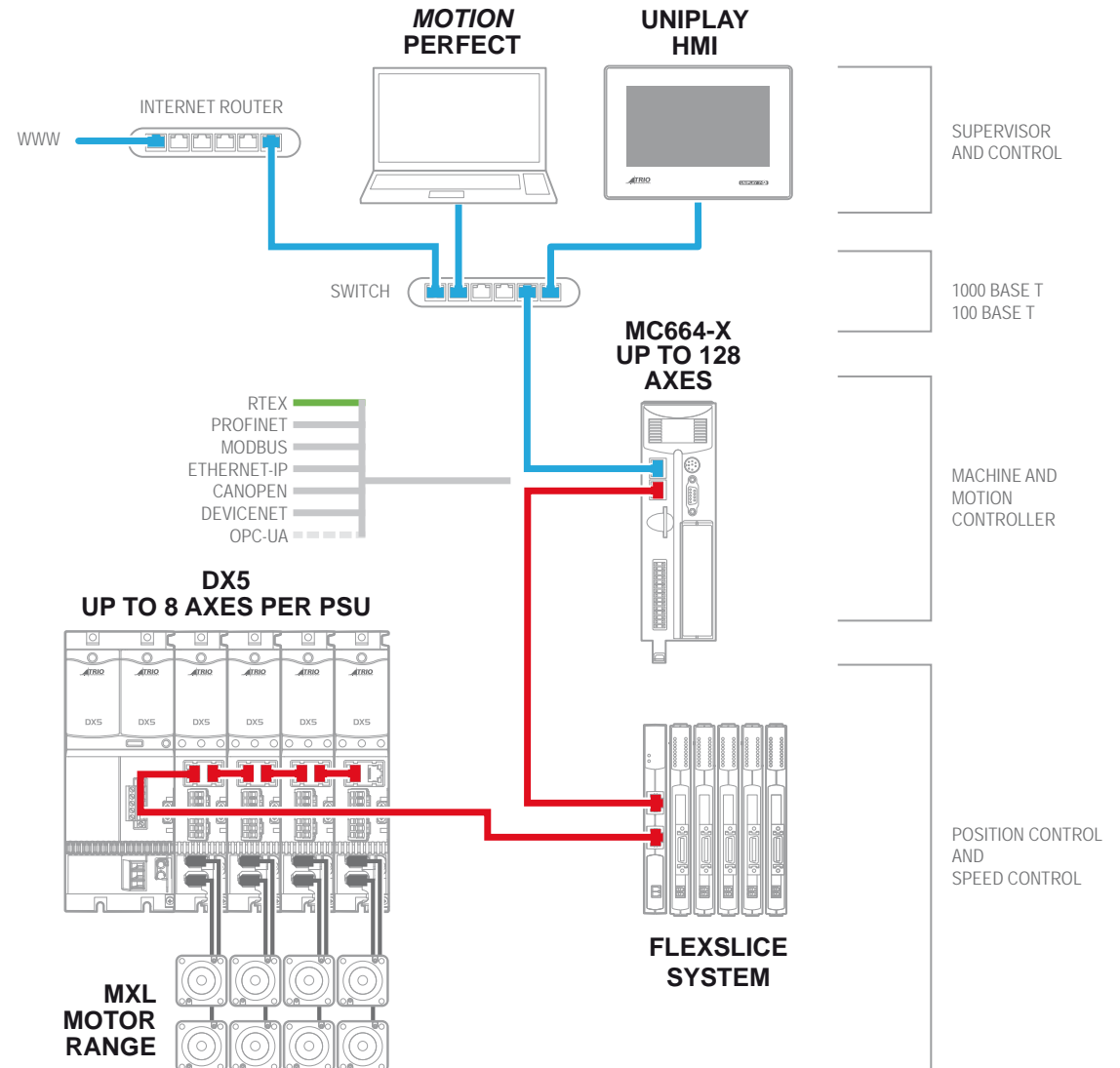

# DX5 Wiring Solution Example

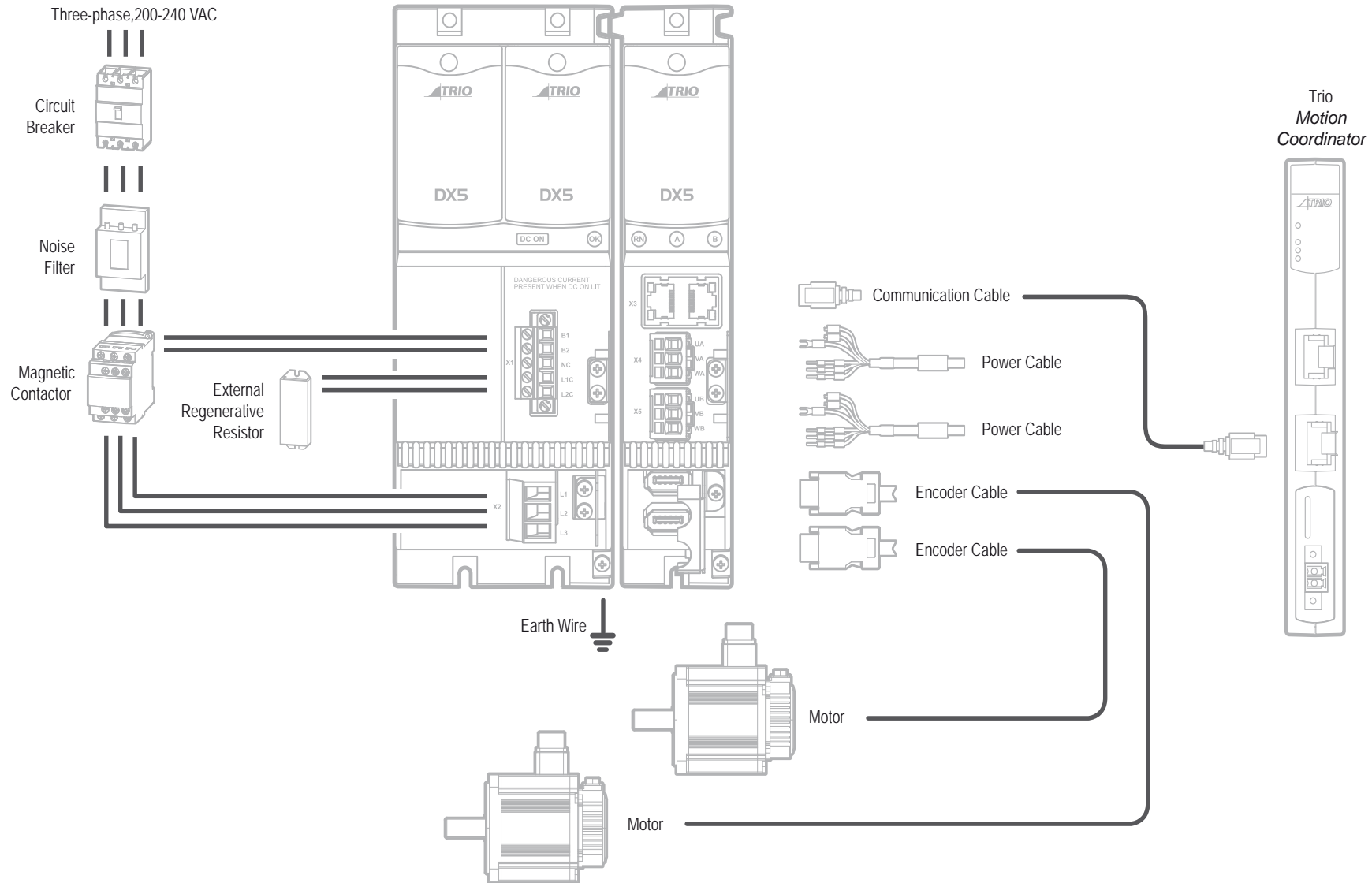

# DX5 Multi-Axis Servo Solutions

## Specification - DX5-20404AEA | DX5-20808AEA - Axis Modules

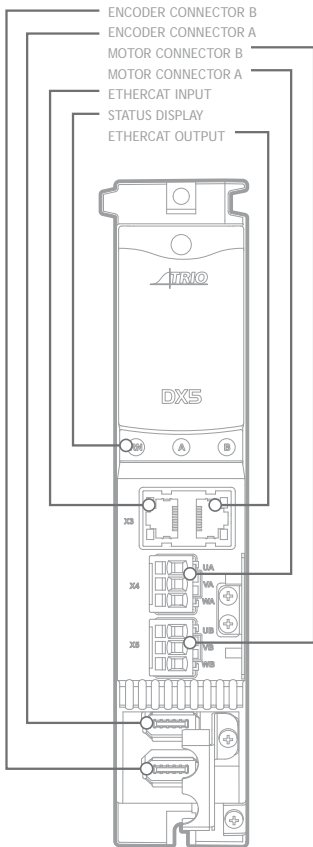

Drive Model: DX5		20404AEA	20808AEA
Continuous Output Power [W]		400	750
Continuous Output Current [Arms]		2.9	5.1
Instantaneous Maximum Output Current [Arms]		11.5	19.5
Power Supply	Main Circuit	270 V dc to 324 V dc, -15% to +10%	
	Control Circuit	24 V dc +/- 10%	
Control Method		SVPWM	
Feedback		Serial encoder: 20-bits single-turn incremental encoder 23-bits single-turn, 16-bits multi-turn absolute encoder	
Environmental Conditions	Temperature	Operating temperature: -5°C to 45°C Storage temperature: -20°C to +85°C	
	Humidity	Both operating and storage: 5% to 95% (with no condensation)	
	Protection Class	IP20	
	Altitude	1,000 m or less	
	Vibration Resistance	4.9 m/s <sup>2</sup>	
	Shock Resistance	19.6 m/s <sup>2</sup>	
	Power System	TN System *3	
Mounting		Base-mounted	
Performance	Speed Control Range	1:5000 ±0.01% of rated speed max. (For a load fluctuation of 0% to 100%)	
	Coefficient of Speed Fluctuation	0% of rated speed max. (For a rated voltage fluctuation of ±10%) ±0.1% of rated speed max. (For a temperature fluctuation of 25°C±25°C)	

Drive Model: DX5		20404AEA	20808AEA	
EtherCAT Communications	Applicable Communications Standards	IEC 61158 Type12, IEC 61800-7 CiA402 Drive Profile		
	Physical Layer	100BASE-TX (IEEE802.3)		
	Communications Connectors	X3 (RJ45 pair): EtherCAT signal input/output connector		
	Cable	Category 5, Shielded/Foiled Twisted Pairs (CAT5e SF/UTP)		
	Sync Manager	SM0: Mailbox output, SM1: Mailbox input, SM2: Process data output, and SM3: Process data input		
	FMMU	FMMU 0: Mapped in process data output (RxPDO) area.		
		FMMU 1: Mapped in process data input (TxPDO) area. FMMU 2: Mapped to mailbox status.		
	EtherCAT Commands (Data Link Layer)	APRD, FPRD, BRD, LRD, APWR, FPWR, BWR, LWR, ARMW, FRMW (APRW, FPRW, BRW, and LRW commands are not supported).		
	Process Data	Assignments can be changed with PDO mapping.		
	MailBox (CoE)	Emergency, SDO request, response, SDO information		
	FoE	File transfer for:		
		Firmware update		
		Parameter values upload/download		
	Distributed Clocks	Scope data upload		
DC Mode, SM2 (SM2 event synchronisation) Applicable DC cycles: 250 µs to 2 ms				
Slave Information Interface	2k bytes EEPROM			
CiA402 Drive Profile	Cyclic Synchronous Position Mode Cyclic Synchronous Velocity Mode Cyclic Synchronous Torque Mode			
Indicator Lamps	RN, A, B, LA1, LA2			
Protective Functions	Over-speed, Over-current, Over-voltage, Under-voltage, Overload, Over-temperature, PSU Failure, EtherCAT Communication Fault, Encoder Feedback Error, IPM failure			
Utility Functions	Alarm history, Jogging, Load inertia identification, Auto-Tuning, etc.			



# DX5 Multi-Axis Servo Solutions

## Specification - DX5-06KANA - PSU

## Dimensions - All Models

PSU Model: DX5		06KANA
Power Supply Input	Main Circuit	Three-phase 200 V ac to 240 V ac -15% to +10%, 50 Hz or 60 Hz
	Control Circuit	Single-phase 200 V ac to 240 V ac -15% to +10%, 50 Hz or 60 Hz
Power Supply Output	DC Bus Power	4200 W
	DC Bus Voltage	270 V dc to 324 V dc, -15% to +10%
	Control Bus Voltage	24 V dc +/- 10%
Environmental Conditions	Temperature	Operating temperature: -5°C to 45°C Storage temperature: -20°C to +85°C
	Humidity	Both operating and storage: 5% to 95% (with no condensation)
	Protection Class	IP20
	Altitude	1,000 m or less
	Vibration Resistance	4.9 m/s <sup>2</sup>
	Shock Resistance	19.6 m/s <sup>2</sup>
	Power System	TN System *3
Regenerative Processing	An external resistor can be connected if the application requires it	
Indicator Lamps	DC_IN, OK	

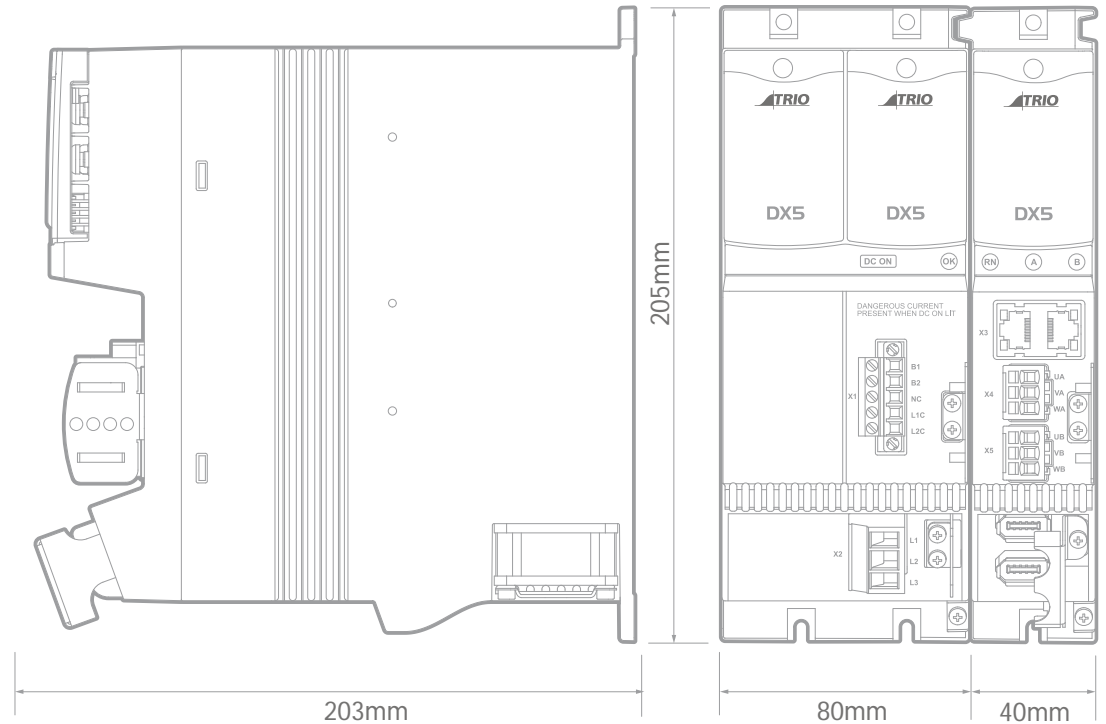
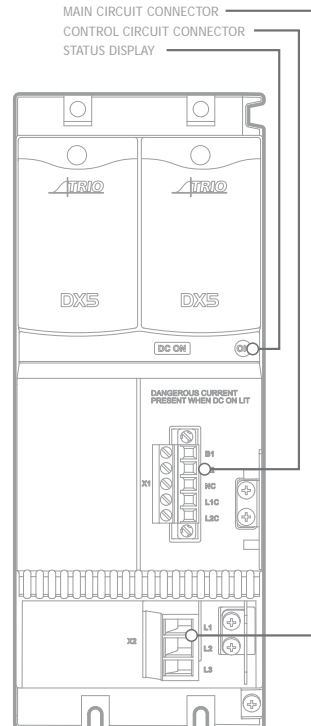

Model No.	Part No	Output Power	Height (mm)	Width (mm)	Depth (mm)
DX5-06KA NA	D0500	PSU	205	80	203
DX5-20404AEA	D0504	400W	205	40	203
DX5-20808AEA	D0508	750W	205	40	203

All Models : Voltage = 200V ac

# MXL Motors

## Low Inertia High Speed (MXL) Servo Motors

### AT A GLANCE

- ★ Choose motor to match the load and dynamics, inertia, brake / no brake
- ★ 23-bit Absolute high performance encoders
- ★ IP65 rated
- ★ Oil seal as standard
- ★ 200V ac supply Voltage

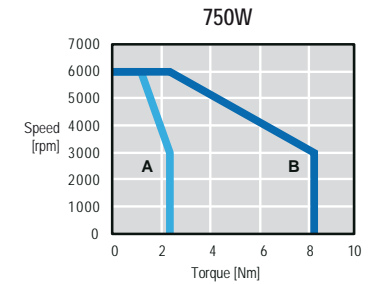
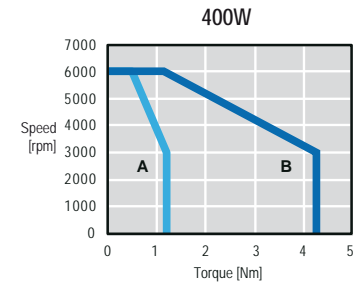
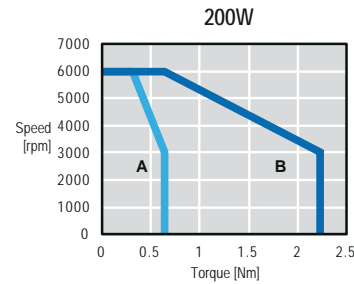
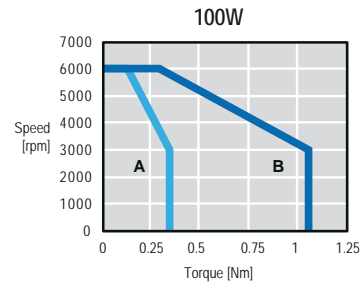

A: Continuous Working Area B: Repeatedly Working Area

Servo Motor Detail		100W	200W	400W	750W
Rated Output	kW	0.1	0.2	0.4	0.75
Rated Torque	N·m	0.318	0.63	1.27	2.39
Instantaneous Peak Torque	N·m	1.11	2.21	4.45	8.37
Rated Current	Arms	1.1	1.5	2.9	5.1
Instantaneous Max current	Arms	4.0	5.8	11.5	19.5
Rated Speed	r/min	3000			
Max. Speed	r/min	6000			
Rotor Moment of Inertia	$\times 10^{-4} \text{kg} \cdot \text{m}^2$	0.0428 (0.0465)	0.147 (0.179)	0.244 (0.276)	0.909 (1.07)
Weight	kg	0.491 (0.696)	0.9 (1.3)	1.3 (1.7)	2.6 (3.2)
Brake Rated Voltage		DC24V $\pm$ 10%			
Brake Rated Power	W	4.0		7.4	9.6
Brake Rated Torque	Nm	0.32		1.5	3.2
Encoder		23-bit Absolute Encoder 8388608P/R			
Insulation Class		F			
Ambient Temperature		0 ~ +40°C (No freezing)			
Ambient Humidity		20%-80% RH (No condensing)			
Vibration		Vibration: Dynamic $\leq 49 \text{m/s}^2$ 5G; Static $\leq 24.5 \text{m/s}^2$ ; Shock: $\leq 98 \text{m/s}^2$ (10G)			
Enclosure		Totally Enclosed, Self-cooled, IP65			

Note: The data inside parenthesis represents the values with brake.

# MXL Motors

## Low Inertia High Speed (MXL) Servo Motors

The MXL family of servo motors include solutions with absolute or incremental encoders, are suitable for application speeds up to 6000 rpm, include variants with an integrated brake.

Low inertia allows very fast response times and these motors develop a very high torque despite their small size. In combination with our servo drives, they are ideal for applications with high dynamic responses and fast and precise positioning.

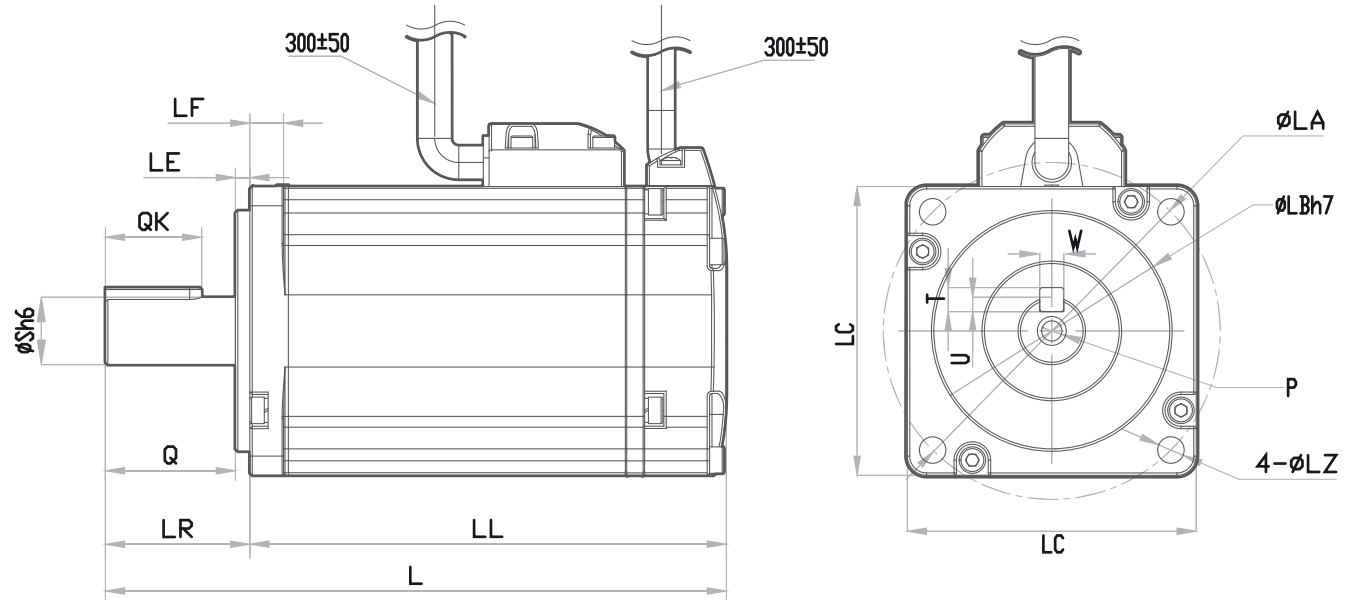

POWER	MXL-	L	LL	Flange Side								S	Threaded hole x Depth	Key				
				LR	LE	LF	LC	LA	LB	LZ	QK			W	T	U	Q	
100W	01A0430L	103.5 (137)	78.5 (112)	25	2.5	5	40	46	30	4.3	8	M3X6	14	3	3	1.8	22.5	
200W	02A0630L	108 (137)	78 (107)	30	3	7	60	70	50	5.5	14	M5X12	20	5	5	3	27	
400W	04A0630L	129 (158)	99 (128)	30	3	7	60	70	50	5.5	14	M5X12	20	5	5	3	27	
750W	08A0830L	141 (184)	111 (144)	40	3	8	80	90	70	6.6	19	M6X12	25	6	6	3.5	37	

Note: Numbers inside parentheses represents the values with brake.

MXL	Rated Power	Supply Voltage	Flange	Rated Speed	Encoder	Revision	Shaft End	Option Parts	Connector Type
01	100W	A 200VAC	04 40mm	30 3000 RPM	L 23-bit abs	A -	2 With key	2 With oil seal	2 Water proof
02	200W		06 60mm					4 With oil seal With brake	
04	400W		08 80mm						
08	750W								

# CABLES

## Encoder Cables

### MXL Motors (50W - 1kW) EC3S-I1724-XX (Inc Encoder)

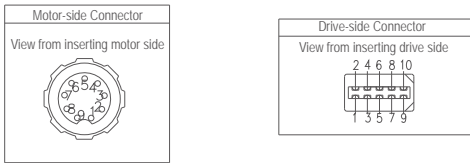

Pin Number	Signal	Pin Number	Signal
1	S+	7	S+
2	S-	8	S-
3	BAT+	9	BAT+
4	MA+	5	MA+
5	MA-	6	MA-
6	PG5V	1	PG5V
7	PG0V	2	PG0V
8	BAT-	10	BAT-
9	FG	Shell	FG

### EC3S-A1724-XX (Abs Encoder)

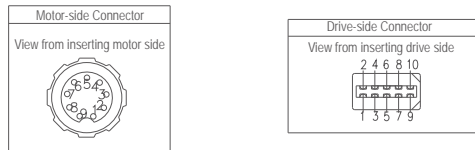
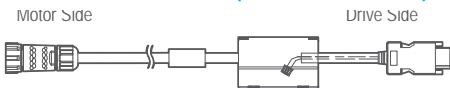

Pin Number	Signal	Pin Number	Signal
1	S+	7	S+
2	S-	8	S-
3	BAT+	9	BAT+
4	MA+	5	MA+
5	MA-	6	MA-
6	PG5V	1	PG5V
7	PG0V	2	PG0V
8	BAT-	10	BAT-
9	FG	Shell	FG



# Power Cables

### MXL Motors (50W - 1kW) EC3P-N8718-XX (No Brake)

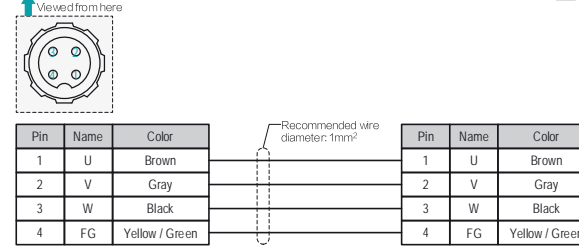
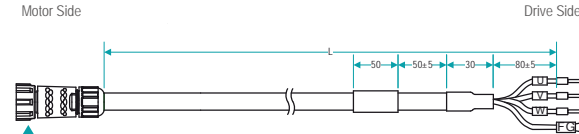

### EC3P-B8718-XX (Brake)

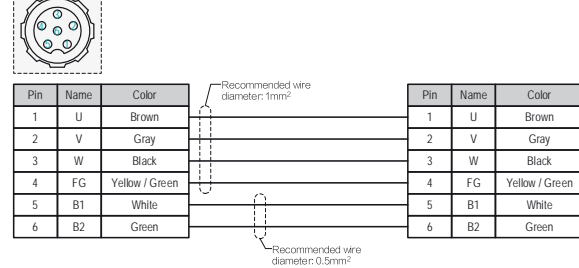
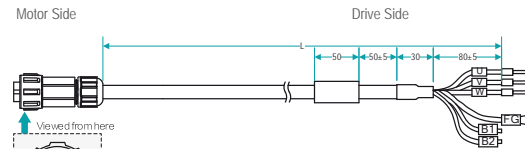

Part No.	Model	Description
X0401	EC3S-I1724-RX-05	5m Incremental Encoder Cable, Flexible, Shielded
X0402	EC3S-I1724-RX-10	10m Incremental Encoder Cable, Flexible, Shielded
X0403	EC3S-I1724-RX-15	15m Incremental Encoder Cable, Flexible, Shielded
X0404	EC3S-I1724-RX-20	20m Incremental Encoder Cable, Flexible, Shielded
X0406	EC3S-A1724-RX-05	5m Absolute Encoder Cable with battery box, Flexible, Shielded
X0407	EC3S-A1724-RX-10	10m Absolute Encoder Cable with battery box, Flexible, Shielded
X0408	EC3S-A1724-RX-15	15m Absolute Encoder Cable with battery box, Flexible, Shielded
X0409	EC3S-A1724-RX-20	20m Absolute Encoder Cable with battery box, Flexible, Shielded
X0501	EC3P-N8718-RX-05	5m Motor Power Cable, Flexible, Unshielded, No brake
X0502	EC3P-N8718-RX-10	10m Motor Power Cable, Flexible, Unshielded, No brake
X0503	EC3P-N8718-RX-15	15m Motor Power Cable, Flexible, Unshielded, No brake
X0504	EC3P-N8718-RX-20	20m Motor Power Cable, Flexible, Unshielded, No brake
X0506	EC3P-B8718-RX-05	5m Motor Power Cable, Flexible, Unshielded, With brake
X0507	EC3P-B8718-RX-10	10m Motor Power Cable, Flexible, Unshielded, With brake
X0508	EC3P-B8718-RX-15	15m Motor Power Cable, Flexible, Unshielded, With brake
X0509	EC3P-B8718-RX-20	20m Motor Power Cable, Flexible, Unshielded, With brake
X0600	EC3S-I1724-XX	Connector pack for Incremental Encoder cable, drive side and motor side connectors
X0601	EC3S-A1724-XX	Connector pack for Absolute Encoder cable, battery box, drive side and motor side connectors
X0700	EC3P-N8718-XX	Connector pack for Motor power cable, No brake
X0701	EC3P-B8718-XX	Connector pack for Motor power cable, With brake

# Selection Table

## Part Numbers

Description	PSU		Drive		Motor		Encoder Cable		Power cable	
	Part No.	Model	Part No.	Model	Part No.	Model	Part No.	Model	Part No.	Model
100W, Low inertia, 23-bit Encoder, No brake	D0500	DX5-06KANA (one PSU supports 4 axis modules)	D0504	DX5-20404AEA	M0756	MXL-01A0430LA222	X0400-X0404 (Inc) X0405-X0409 (Abs)	EC3S-I1724-RX-xx EC3S-A1724-RX-xx	X0500-X0504	EC3P-N8718-RX-xx
200W, Low inertia, 23-bit Encoder, No brake					M0654	MXL-02A0630LA222				
400W, Low inertia, 23-bit Encoder, No brake					M0646	MXL-04A0630LA222				
100W, Low inertia, 23-bit Encoder, With brake					M0757	MXL-01A0430LA242				
200W, Low inertia, 23-bit Encoder, With brake					M0655	MXL-02A0630LA242				
400W, Low inertia, 23-bit Encoder, With brake					M0647	MXL-04A0630LA242				
400W, Low inertia, 23-bit Encoder, No brake			D0508	DX5-20808AEA	M0646	MXL-04A0630LA222			X0500-X0504	EC3P-N8718-RX-xx
750W, Low inertia, 23-bit Encoder, No brake					M0638	MXL-08A0830LA222				
400W, Low inertia, 23-bit Encoder, With brake					M0647	MXL-04A0630LA242				
750W, Low inertia, 23-bit Encoder, With brake					M0639	MXL-08A0830LA242				
								RX:shielded, flexible		RX:unshielded, flexible

Cable lengths available: 5, 10, 15, 20m

*Everything you need... Nothing more*



# TRIO Worldwide Network

**TRIO OFFICES**  
 UK - Tewkesbury HQ  
 USA - Pittsburgh  
 India - Pune  
 China - Shanghai  
 Italy - Milan

**R&D Centres**  
 2 x Control & Software Technology  
 2 x Servo Drives & motors

**EUROPE**  
 BELGIUM  
 DENMARK  
 FRANCE  
 GERMANY

HUNGARY  
**ITALY**  
 NETHERLANDS  
 NORWAY

POLAND  
 PORTUGAL  
 ROMANIA  
 SLOVAKIA

SLOVENIA  
 SPAIN  
 TURKEY

**NORTH AMERICA**  
 ALABAMA  
 ARIZONA  
 CALIFORNIA  
 ONTARIO  
 QUEBEC  
 COLORADO  
 CONNECTICUT  
 FLORIDA  
 GEORGIA  
 ILLINOIS  
 INDIANA  
 IOWA  
 MASSACHUSETTS  
 MEXICO  
 MICHIGAN  
 MINNESOTA  
 MISSISSIPPI  
 NEW JERSEY  
 NEW YORK  
 NORTH CAROLINA  
 OHIO  
**PENNSYLVANIA**  
 SOUTH CAROLINA  
 TENNESSEE  
 TEXAS  
 UTAH  
 VIRGINIA  
 WASHINGTON  
 WISCONSIN

**SOUTH AMERICA**  
 ARGENTINA  
 BRAZIL

**MIDDLE EAST**  
 ISRAEL  
 UAE

**ASIA**  
 INDIA  
 KOREA  
 SINGAPORE  
 TAIWAN  
 THAILAND

**CHINA**  
 BEIJING  
 DONGGUAN  
 GUANGDONG  
**SHANGHAI**  
 YANTAI

**OCEANIA**  
 AUSTRALIA  
 NEW ZEALAND

**4**  
**R&D Centres**

**18**  
**Integrators**

**32**  
**Countries of Sale**

**103**  
**Sales Partners Globally**



A MEMBER OF THE **ESTUN** GROUP

## TRIO MOTION TECHNOLOGY DX5 SERVO PACKAGES



TRIO MOTION TECHNOLOGY  
UK | USA | CHINA | INDIA  
[WWW.TRIOMOTION.COM](http://WWW.TRIOMOTION.COM)

Trio Motion Technology specialises in advanced motion control as a core, providing a range of *Motion Coordinators*, drives and motors, expansion interfaces, I-O modules and HMI's built on *Motion-iX* technologies and designed to enable the control of industrial machines with the minimum of external components.

In support of the Trio concept, we aim to offer the best technical support by telephone, email, our comprehensive website and training courses held throughout the year. Please look at our web site for details.

[www.triomotion.com](http://www.triomotion.com)